

CROSLEY
RADIO

CR712

The AutoRama with CD



Instruction Manual

WARRANTY

Crosley Radio Products are warranted against defects in material and workmanship for a period of 90 days beginning from the date of sale to the original purchaser.

Should the unit fail under normal usage during the 90 day warranty period, a request for RETURN AUTHORIZATION (R.A.) must be made by the original customer before returning the unit. Call Crosley Radio customer service for Return Authorization at (502) 583-4246 from 9 AM to 5 PM (EST) Monday to Friday.

Upon receiving the RETURN AUTHORIZATION number from the Customer Service Department, properly pack your unit in its original packaging. Include any adapters, parts, & accessories which were originally provided with the product, along with a check or money order for \$19.95 made out to Crosley Radio to cover the handling and return postage. Display the R.A. # on the outside of the carton and ship PREPAID via standard UPS or its equivalent.



ATTN: RETURNS DEPT
2001 PRODUCTION DRIVE
BAY 2 & 3
LOUISVILLE, KY 40299

CROSLEY RADIO assumes no responsibility for units sent without prior Return Authorization.

The purchaser's bill of sale is the only proof of warranty entitlement and must accompany the unit.

The warranty does not cover damage due to acts of nature, accident, misuse, abuse, negligence, commercial use or modification of, or to any part of the product. This warranty does not cover damage due to improper operation or maintenance, connection to improper voltage supply, or attempted repair by anyone other than a facility authorized by Crosley Radio to service the product. This warranty does not cover products sold AS IS or consumables (such as fuses or batteries). This warranty is valid only in the United States.

This warranty gives the purchaser specified legal rights in addition to any rights which may vary from state to state.

In accordance with the "Moss-Magnuson Warranty Act" of July 10, 1975, this is termed a "limited warranty" which in no way compromises Crosley Radio, high standards of Quality and Workmanship.

Trouble Shooting

There is no power

- 1 Make sure radio is plugged in correctly.
- 2 Look at the STANDBY light and check to see if it is red.
- 3 If the red light is on, press the STANDBY button. Pressing the STANDBY button should turn the red light to green.

There is no sound

- 1 Make sure the mute function is turned off.
- 2 Check that the volume is turned up by pressing VOL+ button on the control panel or on the remote.

Note: Volume range on some units start at level 15 and ends at level 40.
- 3 Make sure ext./int. switch on back of radio is on int. (unless you are using external speakers, in which case it should be on ext.)

- 4 Check to make sure power is turned on.

CD does not play

- 1 Check to make sure CD is inserted correctly (label side facing up).
- 2 Check to see that surface of CD is clean.
- 3 Make sure radio is on CD function by pressing CD on the control panel.

Remote not working

- 1 Replace batteries.
- 2 Be sure to point the remote towards remote sensor when operating.
- 3 Remove obstacles in the path of the remote and the radio so the remote signal has a straight path to the radio.

Turntable will not work

- 1 Check that the radio is in phono mode.
- 2 Try moving the tone arm to the right until you hear a click.

Presets will not stay programmed

- 1 Make sure that when you turn off the radio, you do not unplug the radio.
- 2 Use the STANDBY button or the POWER button on the remote to turn the power off.

PLEASE READ CAREFULLY ALL THE FOLLOWING IMPORTANT SAFEGUARDS THAT ARE APPLICABLE TO YOUR EQUIPMENT

1. Read Instructions - All the safety and operating instructions should be read before the product is operated.
2. Retain Instructions - The safety and operating instructions should be retained for future reference.
3. Heed Warnings - All warnings on the product and in the operating instructions should be adhered to.
4. Follow Instructions - All operating and use instructions should be followed.
5. Cleaning - Unplug this product from the wall outlet before cleaning. Do not use liquid cleaners or aerosol cleaners. Use a damp cloth for cleaning.
6. Attachments - Do not use attachments not recommended by the product manufacturer as they may cause hazards.
7. Water and Moisture - Do not use this product near water - for example, near a bath tub, wash bowl, kitchen sink, or laundry tub; in a wet basement; or near a swimming pool; and the like.
8. A product and cart combination should be moved with care. Quick stops, excessive force, and uneven surfaces may cause the product and cart combination to overturn.
9. Ventilation - Slots and openings in the cabinet are provided for ventilation and to ensure reliable operation of the product and to protect it from overheating, and these openings must not be blocked or covered. The openings should never be blocked by placing the product on a bed, sofa, rug, or other similar surface. This product should not be placed in a built-in installation such as a bookcase or rack unless proper ventilation is provided or the manufacturer's instructions have been adhered to.
10. Power Sources - This product should be operated only from the type of power source indicated on the marking label, if you are not sure of the type of power supply to your home. Consult your product dealer or local power company. For products intended to operate from battery power, or other sources, refer to the operating instructions.
11. Grounding or Polarization - This product may be equipped with a polarized alternating-current line plug (a plug having one blade wider than the other). This plug will fit into the power outlet only one way. This is a safety feature. If you are unable to insert the plug fully into the outlet try reversing the plug. If the plug should still fail to fit, contact your electrician to replace your obsolete outlet. Do not defeat the safety purpose of the polarized plug.
12. Power - Cord Protection - Power - supply cords should be routed so that they are not likely to be walked on or pinched by items placed upon or against them, paying particular attention to cords at plugs, convenience receptacles, and the point where they exit from the product.
13. Lightning - For added protection for this product during a lightning storm, or when it is left unattended and unused for long periods of time, unplug it from the wall outlet and disconnect the antenna or cable system. This will prevent damage to the product due to lightning and power - line surges.
14. Power Lines - An outside antenna system should not be located in the vicinity of overhead power lines or other electric light or power circuits, or where it can fall into such power lines or circuits. When installing an outside antenna system, extreme care should be taken to keep from touching such power lines or circuits as contact with them might be fatal.
15. Overloading - Do not overload wall outlets, extension cords, or integral convenience receptacles as this can result in a risk of fire or electric shock.
16. Object and Liquid Entry - Never push objects of any kind into this product through openings as they may touch dangerous voltage points or short-out parts that could result in a fire or electric shock. Never spill liquid of any kind on the product.
17. Servicing - Do not attempt to service this product yourself as opening or removing covers may expose you to dangerous voltage or other hazards. Refer all servicing to qualified service personnel.
18. Damage Requiring Service - Unplug this product from the wall outlet and refer servicing to qualified service personnel under the following conditions:
 - a. When the power-supply cord or plug is damaged.
 - b. If liquid has been spilled, or objects have fallen into the product.
 - c. If the product has been exposed to rain or water.
 - d. If the product does not operate normally by following the operating instructions. Adjust only those controls that are covered by the operating instructions as an improper adjustment of other controls may result in damage and will often require extensive work by a qualified technician to restore the product to its normal operation.
 - e. If the product has been dropped or damaged in any way.
 - f. When the product exhibits a distinct change in performance - this indicates a need for service.
19. Replacement Parts - When replacement parts are required, be sure the service technician has used replacement parts specified by the manufacturer or have the same characteristics as the original part. Unauthorized substitutions may result in fire, electric shock, or other hazards.
20. Safety Check - Upon completion of any service or repairs to this product, ask the service technician to perform safety checks to determine that the product is in proper operating condition.
21. Wall or ceiling Mounting - The product should be mounted to a wall or ceiling only as recommended by the manufacturer.
22. Heat - The product should be situated away from heat sources such as radiators, heat registers, stoves, or other products (including amplifiers) that produce heat.

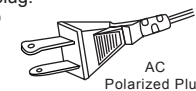

WARNING: Changes or modifications to this unit not expressly approved by the party responsible for compliance could void the user's authority to operate the equipment.



NOTE: This equipment has been tested and found to comply with the limits for a Class B digital device, pursuant to Part 15 of the FCC Rules. These limits are designed to provide reasonable protection against harmful interference in a residential installation. This equipment generates, uses, and can radiate radio frequency energy and, if not installed and used in accordance with the instructions, may cause harmful interference to radio communications. However, there is no guarantee that interference will not occur in a particular installation. If this equipment does cause harmful interference to radio or television reception, which can be determined by turning the equipment off and on, the user is encouraged to try to correct the interference by one or more of the following measures:

- Reorient or relocate the receiving antenna.
- Increase the separation between the equipment and receiver.
- Connect the equipment into a circuit different from that to which the receiver is connected.

Consult the dealer or an experienced radio TV technician for help.

WARNING:

TO PREVENT FIRE OR SHOCK HAZARD, DO NOT EXPOSE THIS APPLIANCE TO RAIN OR MOISTURE. DO NOT REMOVE COVER. PILOT LAMPS SOLDERED IN PLACE. NO USER SERVICEABLE PARTS INSIDE. REFER SERVICING TO QUALIFIED SERVICE PERSONNEL.

 <p>The lightning flash with arrowhead symbol, within an equilateral triangle, is intended to alert user to the presence of uninsulated "dangerous voltage" within the product's enclosure that may be of sufficient magnitude to constitute risk of electric shock to persons.</p>	CAUTION RISK OF ELECTRIC SHOCK CAUTION: TO REDUCE THE RISK OF ELECTRIC SHOCK, DO NOT REMOVE COVER (OR BACK). NO USER - SERVICEABLE PARTS INSIDE. REFER SERVICING TO QUALIFIED SERVICE PERSONNEL.	 <p>The exclamation point within an equilateral triangle is intended to alert user to the presence of important operating and maintenance (servicing) instruction in the literature accompanying the appliance.</p>
--	---	---

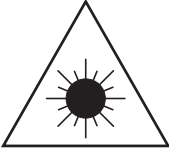
	CAUTION For Compact Disc Units Only: INVISIBLE LASER RADIATION WHEN OPEN AND INTERLOCK FAILED OR DEFEATED. AVOID DIRECT EXPOSURE TO LASER BEAM.
--	--

Specification

Frequency Range	: AM 520 - 1710 KHz
	: FM 87.9 - 108.9 MHz
Power Consumption	: 18 Watts
Antennas	: External FM antenna
	: Built-in ferrite AM bar
Power Source	: AC 120V / 60 Hz
Speaker	: 4" Dynamic type X 2
Speaker Wattage	: 5 Watts
Speaker ohms	: 4 ohms
Output ohms	: 4 ohms
Output Wattage	: 2 Watts per channel

Programming Your CD Player

- 1 In CD mode with a CD inserted and play stopped, press the MEMORY button one time.

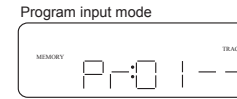

- 2 Select a track you would like to program by using the FORWARD or BACKWARD skip buttons.

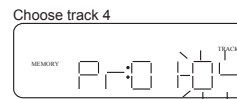

- 3 Once you have selected a track, press the MEMORY button once more. That track is now stored in the memory.

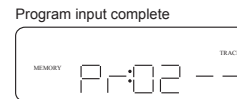

- 4 You can program up to 16 tracks in the memory. Repeat steps 1 - 3 to program selected tracks.
- 5 When all desired tracks are programmed, press the PLAY/PAUSE button to start playback. The programmed tracks will play in the order in which they were programmed.
- 6 To clear the programming, press the MEMORY button one time and then press the STOP button one time. This will clear the programming. The programming will also be cleared if the CD drawer is opened, the power is turned off, or if the radio is unplugged.

Optional External Speakers

- 1 With your new radio, you have the option of adding external speakers.
- 2 The speaker jacks for external speakers are located on the back of the radio. Along with the speaker jacks is a switch labeled int./ ext. When using external speakers, this switch must be switched to the ext. position. Doing this turns off the internal speakers in the radio and redirects the power to the external speakers.
- 3 If you decide not to use the external speakers, be sure the switch is on int. or the internal speakers will not work.

Thank you for purchasing the Crosley 3-in-1 Entertainment Center (CR712). Before operating this unit, please read this manual thoroughly and retain it for future reference.

About This Manual

Instructions in this manual describe the control functions of the CR712 along with the functions of the remote control.

Getting Started

Control Locators.....	4
Unpacking.....	6
Set Up.....	6

Basic Operation

Power Up Your Crosley.....	7
Functions.....	7

Radio

AM/FM Tuning.....	8
Presetting Stations.....	8

Turntable

Setting Turntable Speed.....	9
Playing a Record.....	9

CD Player

Playing a CD.....	10
Programmed Play.....	11

Connecting Optional Equipment

External Speaker.....	11
-----------------------	----

General

Troubleshooting Guide.....	12
Warranty.....	13

Playing a CD

- 1 Press CD on remote control. To load a CD, press the OPEN/CLOSE button one time. This will open the CD drawer.



- 2 Load the desired CD with the label facing up. Press the OPEN/CLOSE button once more to close the CD drawer. Once closed, the CD player will begin to read the track information. When finished reading, the display will read "DISC." Track information will include the total playing time of CD and the number of tracks on the CD.



- 3 Press the PLAY/PAUSE button to begin playback. Playback will start at the beginning of track 1.

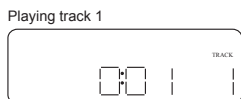

- 4 To skip to a different track, press the FORWARD SKIP or BACKWARD SKIP button until you reach the desired track number. Each press will change the track number by one. Pressing FORWARD SKIP will advance forward from track to track. Pressing the BACKWARD SKIP button will skip backwards from track to track.

- 5 To fast forward during playback, press and hold the FORWARD SKIP button. Fast forwarding stops when the button is released. To rewind (reverse) playback, press and hold the BACKWARD SKIP button.

- 6 To pause playback, press the PLAY/PAUSE button. To continue playback, press the PLAY/PAUSE button once more.

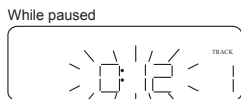

- 7 To repeat playback of a single track or the whole disk, press the REPEAT button. Pressing this button once will repeat only the selected track and a flashing "repeat" will appear on the display. Pressing the repeat button twice will repeat the whole CD when it reaches the end and repeat will appear but will not flash. Pressing repeat a third time will turn off the repeat function.



- 8 To stop playback, press the STOP button.

Unit Controls

- 1) SPEAKER
- 2) SENSOR
- 3) LCD DISPLAY
- 4) STAND BY INDICATOR
- 5) CD OPEN/CLOSE
- 6) PLAY/PAUSE
- 7) STOP
- 8) SKIP BACKWARD/-
- 9) SKIP FORWARD/+
- 10) MEMORY
- 11) CD DOOR
- 12) STAND BY
- 13) TURNTABLE
- 14) SPINDLE
- 15) ADAPTER FOR 45 RPM RECORDS
- 16) TONE ARM
- 17) SPEED CONTROL SWITCH
- 18) ARM REST
- 19) EXTERNAL SPEAKER JACK
- 20) SPEAKER INT. / EXT. SWITCH
- 21) EXTERNAL ANTENNA
- 22) AC POWER PLUG CORD

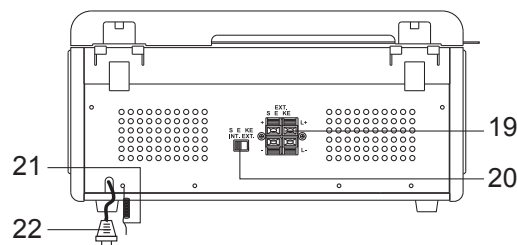
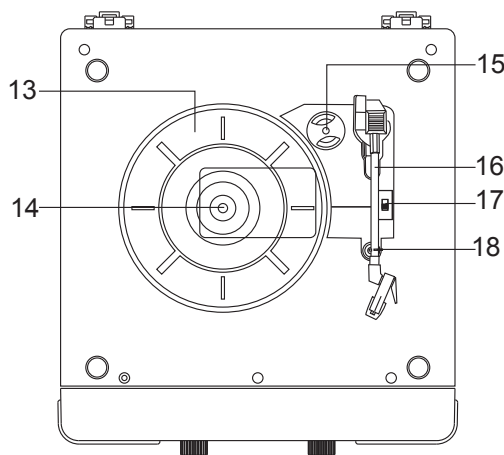
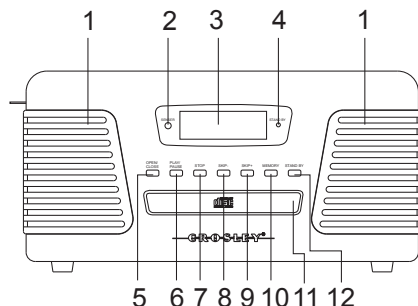

Setting Turntable Speed

- 1 Press the PHONO button on the remote control to set the turntable mode. If playing a 45 rpm record, use the 45 rpm adapter supplied with the turntable.
- 2 Use the speed selector on the turntable to set the rpm to the appropriate speed for the selected record.

Playing a Record

- 1 First, remove the white protective needle cover. Gently lift the tone arm off its rest.
- 2 Move the tone arm slowly to the right side until you hear a click. The turntable should start turning once the click is heard.
- 3 Move the tone arm to the left and lower it gently onto the record to start playing.
- 4 At the end of the record, the turntable will stop turning.
- 5 Lift the tone arm from the record and return it to the arm rest.

AM/FM Tuning

Note: The type of reception bands, the frequency step, and the upper and lower limits of the receiving frequency are dependent on the specifications of the different areas.

- 1 Press the TUNER button on the remote control to enable the tuner.
- 2 Once in tuner mode, press the TUNER button again to select the desired band (FM/AM).

Broadcasting station in AM



- 3 To change stations, push the FORWARD SKIP button to scan up, or the BACKWARD SKIP button to scan down. This radio is also equipped with an auto search function, which will automatically tune in to available stations. To use this function, simply press and hold the FORWARD SKIP or BACKWARD SKIP button (about 1 second) until the display starts searching for stations. Now the radio will stop on the next station that it can tune in.

Note: If the FORWARD or BACKWARD skip buttons are pushed during autosearch, the searching will stop at that point.

- 4 To manually search for a station, push the FORWARD or BACKWARD skip button one press at a time until the desired station is found.

- 5 In FM mode, there will be a "stereo" displayed on the LCD when a station broadcasting in stereo is received.

Stereo reception



Presetting Stations

- 1 You can store up to 20 FM stations and 12 AM stations into the preset memory.
- 2 To program a preset, begin by tuning the radio to a desired station by using either auto or manual search.

Search a desired station

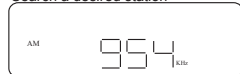

- 3 Once a desired channel is located, press the MEMORY button one time. You will see (--) flashing on the right side of the display.

Choose track 4

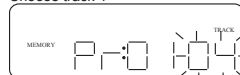

- 4 Press the REPEAT button to select the desired preset number. The preset number will increase by one each time it is pressed. Example: The first time the REPEAT button is pressed, you will see a "1". Press the button twice and a "2" will display. The number you select will be the number of the preset for the selected station.

Choose Channel 1

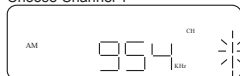

- 5 Press MEMORY one last time and the selected station is stored.

Channel 1 presetting finish

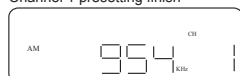

- 6 Repeat steps 2 - 5 until all desired stations have been programmed.
- 7 Once all of the desired stations have been programmed, press the REPEAT button to select presets.
- 8 Unplugging until will erase all presets.

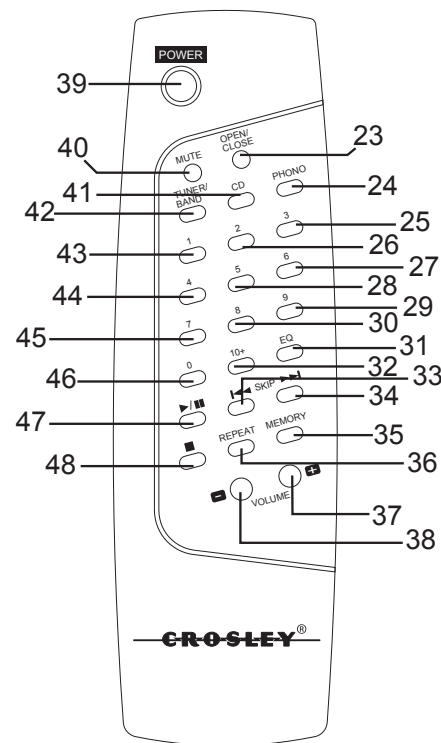

Remote Controls

- 23) OPEN/CLOSE
- 24) PHONO
- 25) 3
- 26) 2
- 27) 6
- 28) 5
- 29) 9
- 30) 8
- 31) EQ
- 32) 10+
- 33) SKIP BACKWARD
- 34) SKIP FORWARD
- 35) MEMORY
- 36) REPEAT
- 37) VOLUME UP
- 38) VOLUME DOWN
- 39) POWER STAND BY
- 40) MUTE
- 41) CD
- 42) TUNER/BAND
- 43) 1
- 44) 4
- 45) 7
- 46) 9
- 47) PLAY/PAUSE
- 48) STOP

Unpacking

- 1 Remove packing materials from unit.
Note: Save all packing materials.
- 2 Remote control is located in the outside of the styrofoam packaging.
- 3 Remove plastic bag covering radio and remote control.
- 4 Remove plastic safety cover from A/C plug.
- 5 Remove tie from A/C cord and untie antenna wire on back of radio.
- 6 Open lid and remove styrofoam shipping material from turntable.
- 7 Remove black tie-wrap from under the tone arm.
- 8 Remove white protective needle cover by gently pulling towards the front of the unit.

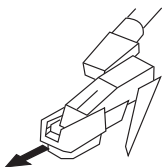

Set Up

- 1 Install 2 AAA batteries (not included) in remote control.
- 2 Plug A/C cord into appropriate outlet.

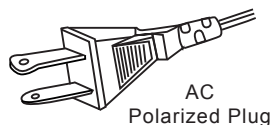

Note: This product may be equipped with a polarized alternating-current line plug (a plug having one blade wider than the other.) This plug will fit into the power outlet only one way. This is a safety feature. If you are unable to insert the plug fully into the outlet try reversing the plug, if the plug should still fail to fit, contact your electrician to replace your obsolete outlet. Do not defeat the safety purpose of the polarized plug.

- 3 Untie the FM antenna and allow it to hang down in a straight line for optimum FM reception. If you have trouble tuning in an FM station, move the external FM antenna for best reception. Do not connect FM antenna to outside antenna.

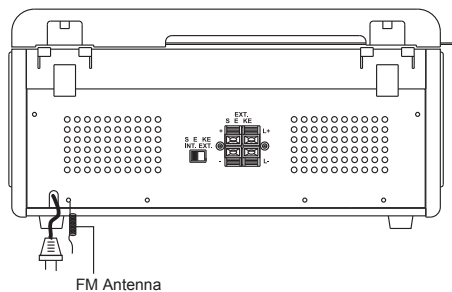

Power Up Your Crosley

Your new Crosley is equipped with a POWER / STANDBY button. Press the POWER / STANDBY button on either the front of the unit or on your remote control. The Standby light will turn from red to green. When turned off, the standby light will turn red. During standby mode, all presets will remain programmed in your unit.

Functions

Electronic Volume Control

- 1 Press the VOL+ button to increase the volume. The volume level will be shown in the LCD display.

Electronic volume control display



- 2 Press the VOL- button to decrease the volume.
- 3 Press and hold either the VOL+ or the VOL- button to continuously increase or decrease the volume. The volume will continue to increase or decrease until the button is released.
- 4 Press the MUTE button to set the volume to 0. Press the MUTE button again to return to the previous volume level.

Functions (cont.)

Function Select

- 1 Press the TUNER button on remote to enable the AM/ FM tuning function. When in tuner mode, the LCD will display the band (AM/FM), and the station frequency.

Receiving tuning frequency display



- 2 Press the CD button on remote to set to CD mode. When first set to CD mode, the display will search for CD and track information.

CD TOC reading display

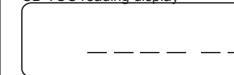

After reading display

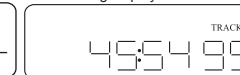

- 3 Press the PHONO button on remote to set to phono mode. When in phono mode, the display will read "LINE".

Phono display



Equalizer

- 1 Your radio has a built in equalizer. The equalizer fine tunes the sound according to the type of music you like. Pressing the EQ button results in the following changes:



Equalizer "ROCK"

