

**CROSLY**  
**RADIO**

**CR249**

**KEEPSAKE USB Turntable**

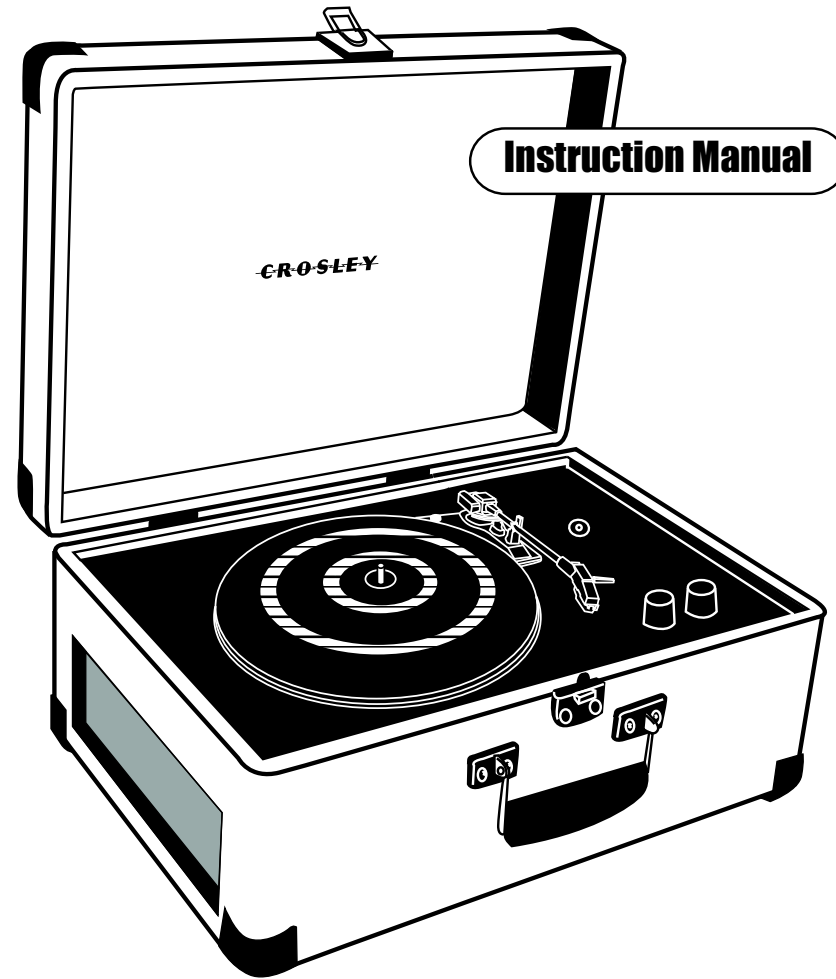

## WARRANTY

Crosley Radio Products are warranted against defects in material and workmanship for a period of 90 days beginning from the date of sale to the original purchaser.

Should the unit fail under normal usage during the 90 day warranty period, a request for RETURN AUTHORIZATION (R.A.) must be made by the original customer before returning the unit. Call Crosley Radio customer service for Return Authorization at (502) 583-4246 from 9 AM to 5 PM (EST) Monday to Friday.

Upon receiving the RETURN AUTHORIZATION number from the Customer Service Department, properly pack your unit in its original packaging. Include any adapters, parts, & accessories which were originally provided with the product, along with a check or money order for \$19.95 made out to Crosley Radio to cover the handling and return postage. Display the R.A. # on the outside of the carton and ship PREPAID via standard UPS or its equivalent.

**CROSLEY  
RADIO**

ATTN: RETURNS DEP'T  
2001 PRODUCTION DRIVE  
BAY 2 & 3  
LOUISVILLE, KY 40299

CROSLEY RADIO assumes no responsibility for units sent without prior Return Authorization.

The purchaser's bill of sale is the only proof of warranty entitlement and must accompany the unit.

The warranty does not cover damage due to acts of nature, accident, misuse, abuse, negligence, commercial use or modification of, or to any part of the product. This warranty does not cover damage due to improper operation or maintenance, connection to improper voltage supply, or attempted repair by anyone other than a facility authorized by Crosley Radio to service the product. This warranty does not cover products sold AS IS or consumables (such as fuses or batteries). This warranty is valid only in the United States.

This warranty gives the purchaser specified legal rights in addition to any rights which may vary from state to state.

In accordance with the "Moss-Magnuson Warranty Act" of July 10, 1975, this is termed a "limited warranty" which in no way compromises Crosley Radio, high standards of Quality and Workmanship.

## IMPORTANT SAFETY INSTRUCTION

### PLEASE READ CAREFULLY ALL THE FOLLOWING IMPORTANT SAFEGUARDS THAT ARE APPLICABLE TO YOUR EQUIPMENT

1. Read Instructions - All the safety and operating instructions should be read before the product is operated.
2. Retain instructions - The safety and operating instructions should be retained for future reference.
3. Heed Warnings - All warnings on the product and in the operating instructions should be adhered to.
4. Follow Instructions - All operating and use instructions should be followed.
5. Cleaning - Unplug this product from the wall outlet before cleaning. Do not use liquid cleaners or aerosol cleaners. Use a damp cloth for cleaning.
6. Attachments - Do not use attachments not recommended by the product manufacturer as they may cause hazards.
7. Water and Moisture - Do not use this product near water - for example, near a bath tub, wash bowl, kitchen sink, or laundry tub; in a wet basement; or near a swimming pool; and the like.
8. A product and cart combination should be moved with care. Quick stops, excessive force, and uneven surfaces may cause the product and cart combination to overturn.
9. Ventilation - Slots and openings in the cabinet are provided for ventilation and to ensure reliable operation of the product and to protect it from overheating, and these openings must not be blocked or covered. The openings should never be blocked by placing the product on a bed, sofa, rug, or other similar surface. This product should not be placed in a built-in installation such as a bookcase or rack unless proper ventilation is provided or the manufacturer's instructions have been adhered to.
10. Power Sources - This product should be operated only from the type of power source indicated on the marking label, if you are not sure of the type of power supply to your home. Consult your product dealer or local power company. For products intended to operate from battery power, or other sources, refer to the operating instructions.
11. Grounding or Polarization - This product may be equipped with a polarized alternating-current line plug (a plug having one blade wider than the other). This plug will fit into the power outlet only one way. This is a safety feature. If you are unable to insert the plug fully into the outlet try reversing the plug. If the plug should still fail to fit, contact your electrician to replace your obsolete outlet. Do not defeat the safety purpose of the polarized plug.
12. Power - Cord Protection - Power - supply cords should be routed so that they are not likely to be walked on or pinched by items placed upon or against them, paying particular attention to cords at plugs, convenience receptacles, and the point where they exit from the product.
13. Lightning - For added protection for this product during a lightning storm, or when it is left unattended and unused for long periods of time, unplug it from the wall outlet and disconnect the antenna or cable system. This will prevent damage to the product due to lightning and power - line surges.
14. Power Lines - An outside antenna system should not be located in the vicinity of overhead power lines or other electric light or power circuits, or where it can fall into such power lines or circuits. When installing an outside antenna system, extreme care should be taken to keep from touching such power lines or circuits as contact with them might be fatal.
15. Overloading - Do not overload wall outlets, extension cords, or integral convenience receptacles as this can result in a risk of fire or electric shock.
16. Object and Liquid Entry - Never push objects of any kind into this product through openings as they may touch dangerous voltage points or short - out parts that could result in a fire or electric shock. Never spill liquid of any kind on the product.
17. Servicing - Do not attempt to service this product yourself as opening or removing covers may expose you to dangerous voltage or other hazards. Refer all servicing to qualified service personnel.
18. Damage Requiring Service - Unplug this product from the wall outlet and refer servicing to qualified service personnel under the following conditions;
  - a. When the power-supply cord or plug is damaged.
  - b. If liquid has been spilled, or objects have fallen into the product.
  - c. If the product has been exposed to rain or water.
  - d. If the product does not operate normally by following the operating instructions. Adjust only those controls that are covered by the operating instructions as an improper adjustment of other controls may result in damage and will often require extensive work by a qualified technician to restore the product to its normal operation.
  - e. If the product has been dropped or damaged in any way.
  - f. When the product exhibits a distinct change in performance - this indicates a need for service.
19. Replacement Parts - When replacement parts are required, be sure the service technician has used replacement parts specified by the manufacturer or have the same characteristics as the original part. Unauthorized substitutions may result in fire, electric shock, or other hazards.
20. Safety Check - Upon completion of any service or repairs to this product, ask the service technician to perform safety checks to determine that the product is in proper operating condition.
21. Wall or ceiling Mounting - The product should be mounted to a wall or ceiling only as recommended by the manufacturer.
22. Heat - The product should be situated away from heat sources such as radiators. Heat registers, stoves, or other products (including amplifiers) that produce heat.

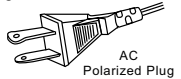

**WARNING:** Changes or modifications to this unit not expressly approved by the party responsible for compliance could void the user's authority to operate the equipment.

**NOTE:** This equipment has been tested and found to comply with the limits for a Class B digital device, pursuant to Part 15 of the FCC Rules. These limits are designed to provide reasonable protection against harmful interference in a residential installation. This equipment generates, uses, and can radiate radio frequency energy and, if not installed and used in accordance with the instructions, may cause harmful interference to radio communications. However, there is no guarantee that interference will not occur in a particular installation. If this equipment does cause harmful interference to radio or television reception, which can be determined by turning the equipment off and on, the user is encouraged to try to correct the interference by one or more of the following measures:

- Reorient or relocate the receiving antenna.
- Increase the separation between the equipment and receiver.
- Connect the equipment into a circuit different from that to which the receiver is connected.
- Consult the dealer or an experienced radio TV technician for help.

# Operation

## Turntable Operation

- 1 Turn the unit on by rotating the ON/OFF-VOLUME KNOB (7) clockwise.
- 2 Set the SPEED CONTROL SWITCH (4) to the correct speed (33 1/3, 45 or 78 rpm).
- 3 Place the record on the turntable.
- 4 Use the CUE LEVER (2) to raise the tone arm off its rest. Move the tone arm over the record and use the cue lever to lower it onto the record. The record will begin to turn automatically.
- 5 At the end of the record, the tone arm will return to its rest.

## USB Operation

Using the included software and cable, the USB connection allows you record your records onto your computer. Follow these instructions to use the USB.

- 1 Insert the enclosed software CD into your computer.
- 2 Follow the instructions on the computer screen to install the software. If the software does not load automatically, browse the CD and open the Read Me folder for further instructions.
- 3 Connect the small end of the USB cable to the USB JACK (15) on the back of the unit.
- 4 Connect the other end to a USB port on your computer.
- 5 On your computer, open the Record Recording Software.
- 6 For instructions on operating the Record Recording Software, browse the software CD and open the Read Me folder.

## Accessory: ADAPTER FOR 45 RPM

This adaptor allows you to play 45 RPM records.



- 1 Place the 45 RPM adaptor over the spindle.
- 2 Gently place your 45 RPM record onto the turntable.
- 3 Follow the steps under turntable operation to play your record.

# Welcome

Thank you for purchasing the Crosley Keepsake (CR249). Before operating this unit, please read this manual thoroughly and retain it for future reference.

## About This Manual

Instructions in this manual describe the control functions of the CR249.

- Included in this package:
- Keepsake USB Turntable
  - Record Recording Software
  - USB Cable
  - 45rpm Adapter

# Table of Contents

## Getting Started

Unpacking.....	4
Power Source.....	4
Control Locators.....	5

## Operation





General.....	6
USB/Recording.....	6

## General

Troubleshooting Guide.....	7
Warranty.....	8

# WARNING:

TO PREVENT FIRE OR SHOCK HAZARD, DO NOT EXPOSE THIS APPLIANCE TO RAIN OR MOISTURE. DO NOT REMOVE COVER. PILOT LAMPS SOLDERED IN PLACE. NO USER SERVICEABLE PARTS INSIDE. REFER SERVICING TO QUALIFIED SERVICE PERSONNEL.

	<b>CAUTION</b> <b>RISK OF ELECTRIC SHOCK</b> <b>DO NOT OPEN</b>	
<b>CAUTION:</b> TO REDUCE THE RISK OF ELECTRIC SHOCK, DO NOT REMOVE COVER (OR BACK). NO USER - SERVICEABLE PARTS INSIDE. REFER SERVICING TO QUALIFIED SERVICE PERSONNEL.		
	The lightning flash with arrowhead symbol, within an equilateral triangle, is intended to alert user to the presence of uninsulated "dangerous voltage" within the product's enclosure that may be of sufficient magnitude to constitute risk of electric shock to persons.	
	The exclamation point within an equilateral triangle is intended to alert user to the presence of important operating and maintenance (servicing) instruction in the literature accompanying the appliance.	

# SPECIFICATION

- Power Supply : AC adapter -(DC 12V 0.5A)(Included)
- Power Consumption : 12W
- Speed : 33<sup>1</sup>/<sub>3</sub> / 45 /78 RPM
- Speaker : 3 x 5" Dynamic Type x 2
- Replacement Needle : NP4

•DESIGN AND SPECIFICATION SUBJECT TO CHANGE WITHOUT NOTICE.



1220 East Oak Street • Louisville, Kentucky 40204  
www.crosleyradio.com

910-264500-0010-100

## General

### Troubleshooting

#### The unit does not operate.

- 1 The AC Power cord is not connected. Make sure it is connected to an AC outlet and the back of the unit.
- 2 The unit is not turned on : rotate the VOLUME knob from the OFF position.

#### Turntable

No sound is coming from unit.

- 1 The white protective needle cover was not removed.
- 2 The volume is not turned unit.

Tone arm will not move.

- 1 Block tie-wrap was not removed from underneath tone arm.
- 2 Tone arm hold down clip was not released.

Needles are available for additional charges, please call us at 1-800-926-7801 for assistance

www.crosleyradio.com

## Getting Started

### Unpacking

- 1 Remove packing materials from unit.  
Note: Save all packing materials.
- 2 Remove plastic bag covering radio.
- 3 Remove AC ADAPTER from packing.
- 4 Remove tie from A/C ADAPTER.
- 5 Open lid and remove styrofoam shipping material from turntable.
- 6 Remove black tie-wrap from under the tone arm.
- 7 Remove white protective needle cover by gently pulling towards the front of the unit.

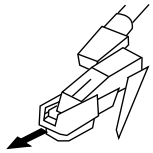

- 8 Turn the TURNTABLE SUSPENSION SCREW (31) clockwise until it is all the way down. Do not force or over tighten it. This allows the turntable to float on its shock absorbers.

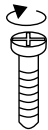

- 9 Release tone arm hold down clip by gently pushing to the right. This will unlock tone arm from its arm rest. Re-lock the hold down clip when moving the unit to another location.

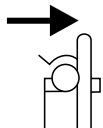

4

### Power Source

- 1 Untie the wire on the AC ADAPTER (16).
- 2 Plug the AC ADAPTER into appropriate wall outlet.
- 3 Plug the small end of the adapter into the ADAPTER JACK (12) on the back of the unit.

### Unit Controls

1. Tone Arm
2. Cue lever
3. Power light indicator
4. Speed control switch
5. Security Hook
6. Tone Control
7. ON/OFF Volume Knob
8. Tone Arm Rest
9. Turntable
10. Adapter for 45 RPM records
11. Speaker
12. Adapter Jack
13. Aux In Jack
14. Aux In Phono on/off
15. USB Jack
16. AC Adapter  
(placed in a white cardboard box inside the styrofoam packaging)

## Control Locators

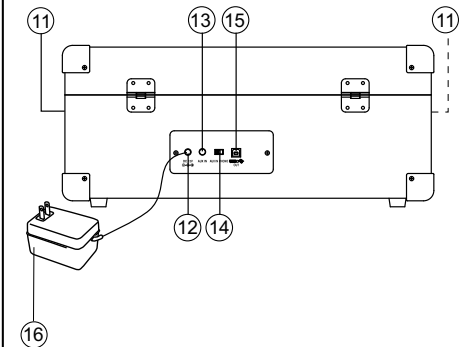
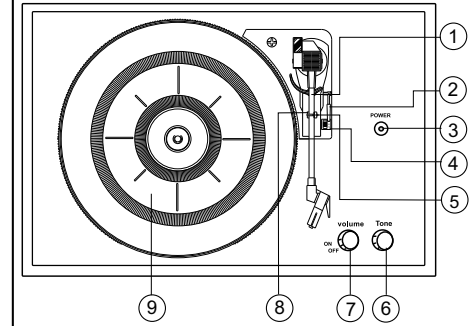

5